

R+4 : habitation
plancher bois
structure bois

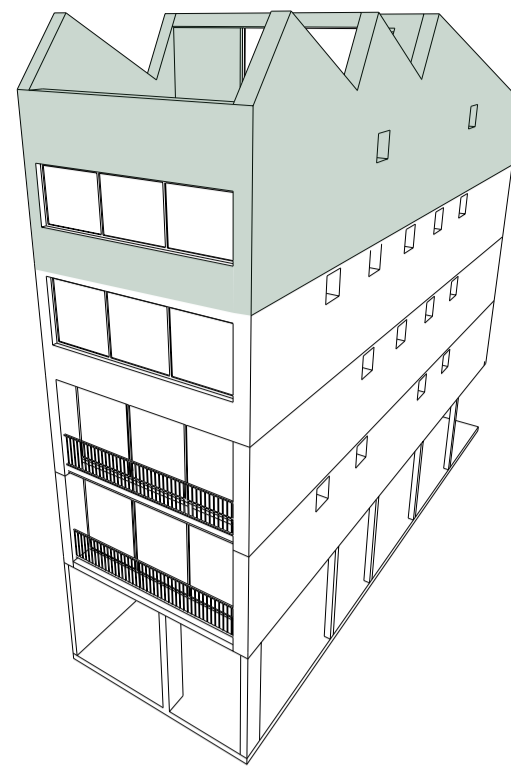

R+3 : habitation
plancher bois
structure bois

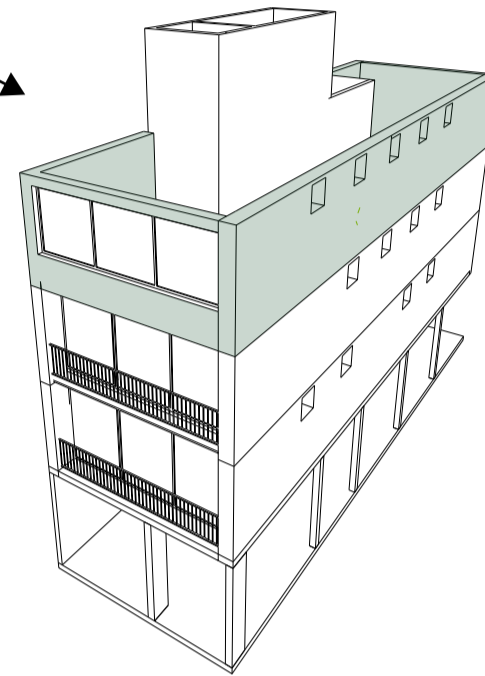

R+2 : plateau de bureaux
plancher bois
structure bois

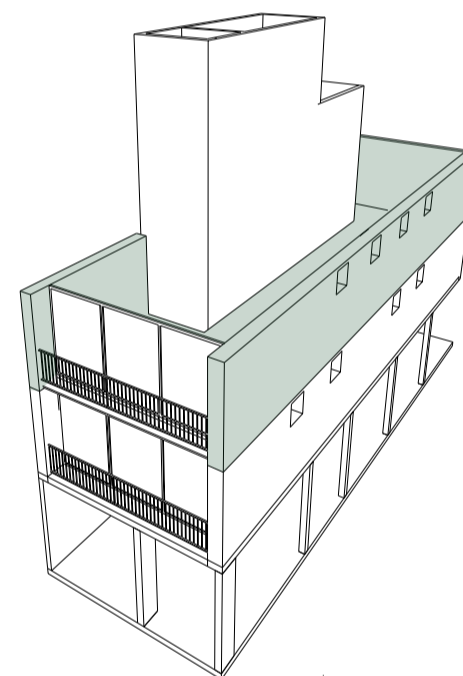

R+1 / plateau de bureaux
plancher bois
structure bois

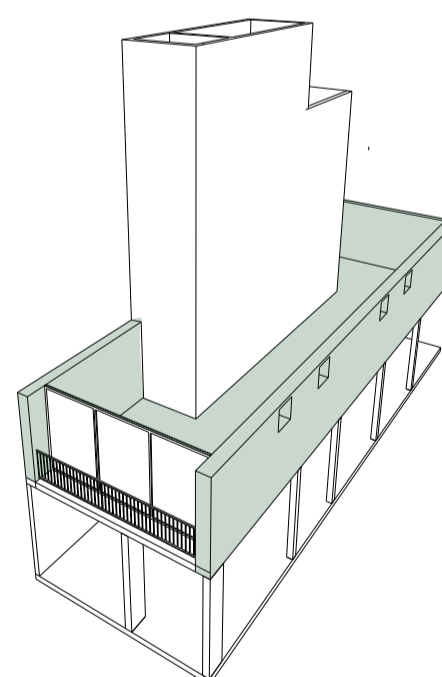

RDC
plancher béton
poteaux béton
cage d'escalier en béton

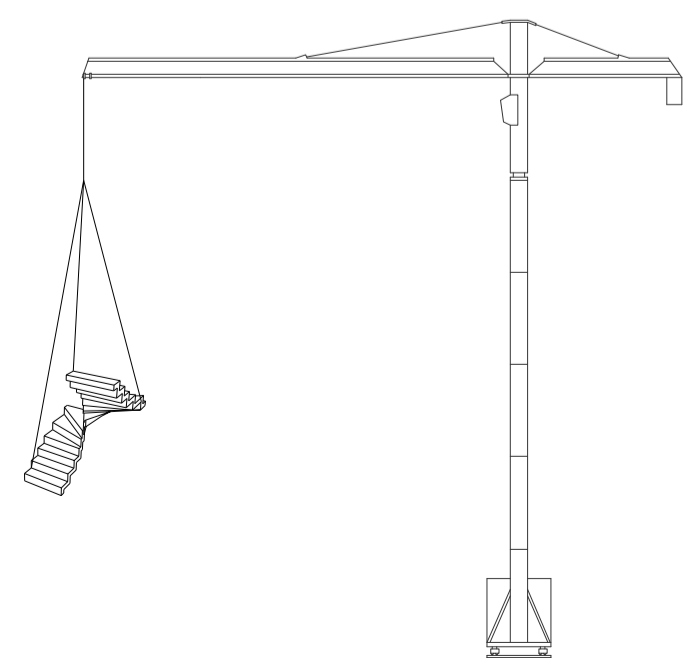
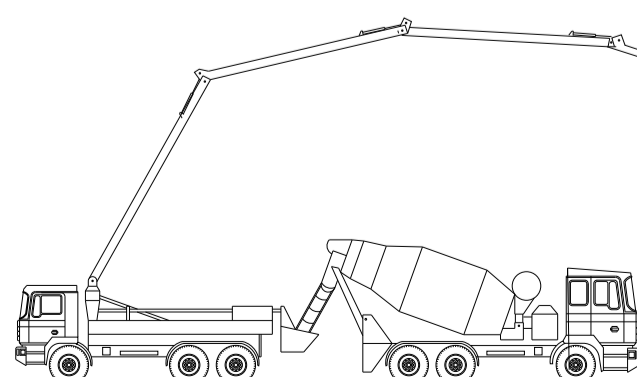
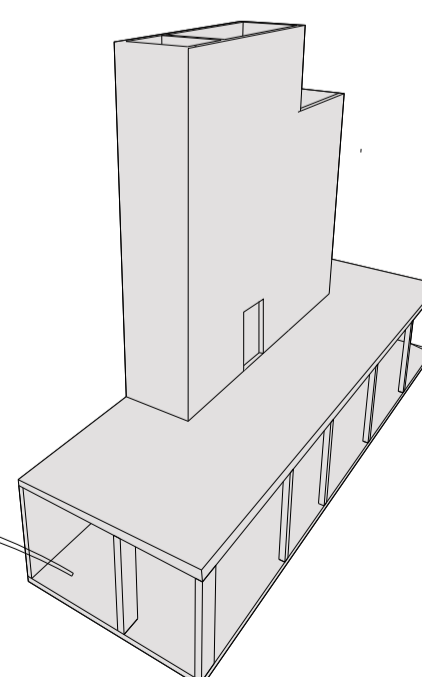

chantier sec
6 MOIS

MOB avec bardage assemblé sur place

